

Measuring insert For process resistance thermometer Model TR12-A

WIKA data sheet TE 60.16



for further approvals
see page 2

Applications

- Replacement measuring insert for servicing

Special features

- Application ranges from -200 ... +600 °C
[-328 ... +1,112 °F]
- Made of mineral-insulated sheathed measuring cable
- Explosion-protected versions (option)



Measuring insert for process resistance thermometer,
model TR12-A

Description

The measuring inserts described here are intended for installation in model TR12-B or TR12-M process resistance thermometers (see figures at right). Operation without thermowell is only recommended in certain applications.

The measuring insert is made of flexible, mineral-insulated sheathed cable. The sensor is located in the tip of the measuring insert.

Type and number of sensors, accuracy and connection method can each be selected to suit the respective application.



Model TR12-B

Model TR12-M

Explosion protection (measuring insert built in TR12-B)

The permissible power, P_{max} , as well as the permissible ambient temperature, for the respective category can be seen on the certificate for hazardous areas or in the operating instructions.

Attention:









Built into a model TR12-B process resistance thermometer - depending on the version - a measuring insert with "intrinsic safety Ex i" or "flameproof enclosure Ex d" ignition protection type can be used. One such measuring insert, suitable for Ex d, is marked Ex i.

The use of a model TR12-A measuring insert is not permitted in hazardous areas without a suitable protective fitting.



Example: Model TR12-B

Approvals (explosion protection, further approvals)

Logo	Description	Country
 	EU declaration of conformity <ul style="list-style-type: none"> ■ EMC directive ¹⁾ EN 61326 emission (group 1, class B) and interference immunity (industrial application) ■ RoHS directive ■ ATEX directive (option) Hazardous areas - Ex i Zone 1 gas II 2G Ex ia IIC T1 ... T6 Gb 	European Union
	IECEx (option) (in conjunction with ATEX) Hazardous areas - Ex i Zone 1 gas Ex ia IIC T1 ... T6 Gb	International
	EAC (option) Hazardous areas - Ex i Zone 0 gas 0Ex ia IIC T6 ... T1 Ga X	Eurasian Economic Community
	Ex Ukraine (option) Hazardous areas - Ex i Zone 0 gas II 1G Ex ia IIC T1 ... T6 Ga	Ukraine
	CCC (Option) Hazardous areas - Ex i Zone 0 gas Ex ia IIC T1 ~ T6 Ga - Ex e ²⁾ Zone 1 gas Ex eb IIC T1 ~ T6 Gb - Ex n Zone 2 gas Ex nA IIC T1 ~ T6 Gc	China
	KCs - KOSHA (option) Hazardous areas - Ex i Zone 1 gas Ex ib IIC T4 ... T6	South Korea
-	PESO (option) Hazardous areas - Ex i Zone 1 gas Ex ia IIC T1 ... T6 Gb	India
	GOST (option) Metrology, measurement technology	Russia
	KazInMetr (option) Metrology, measurement technology	Kazakhstan
-	MTSCHS (option) Permission for commissioning	Kazakhstan

Logo	Description	Country
	BelGIM (option) Metrology, measurement technology	Belarus
	Uzstandard (option) Metrology, measurement technology	Uzbekistan

1) Only for built-in transmitter in the complete instrument TR12-B

2) Only with connection head, model 1/4000, 5/6000 or 7/8000 (see "Connection head") in the complete instrument TR12-B

Instruments marked with "ia" may also be used in areas only requiring instruments marked with "ib" or "ic".

If an instrument with "ia" marking has been used in an area with requirements in accordance with "ib" or "ic", it can no longer be operated in areas with requirements in accordance with "ia" afterwards.

Approvals and certificates, see website

Sensor

Measuring element

Pt100 (measuring current: 0.1 ... 1.0 mA) ¹⁾

Connection method	
Single elements	1 x 2-wire 1 x 3-wire 1 x 4-wire
Dual elements	2 x 2-wire 2 x 3-wire 2 x 4-wire ²⁾

Electrical connection

(Colour code per IEC/EN 60751)

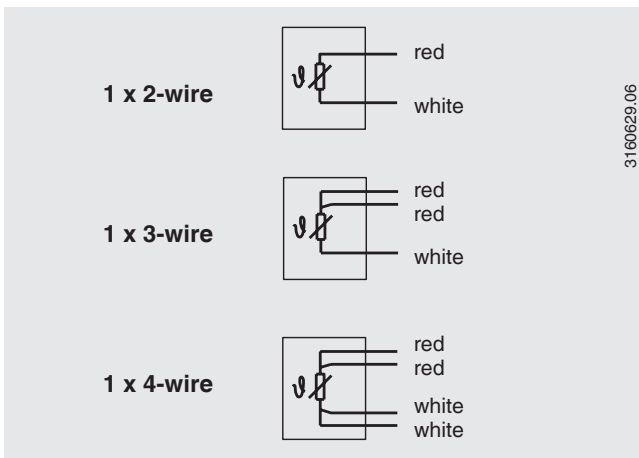

Tolerance value of the measuring element per EN 60751		
Class	Sensor construction	
	Wire-wound	Thin-film
Class B	-200 ... +600 °C	-50 ... +500 °C
Class A ³⁾	-100 ... +450 °C	-30 ... +300 °C
Class AA ³⁾	-50 ... +250 °C	0 ... 150 °C

1) For detailed specifications for Pt100 sensors, see Technical information IN 00.17 at www.wika.com.

2) Not with 3 mm diameter

3) Not with 2-wire connection method

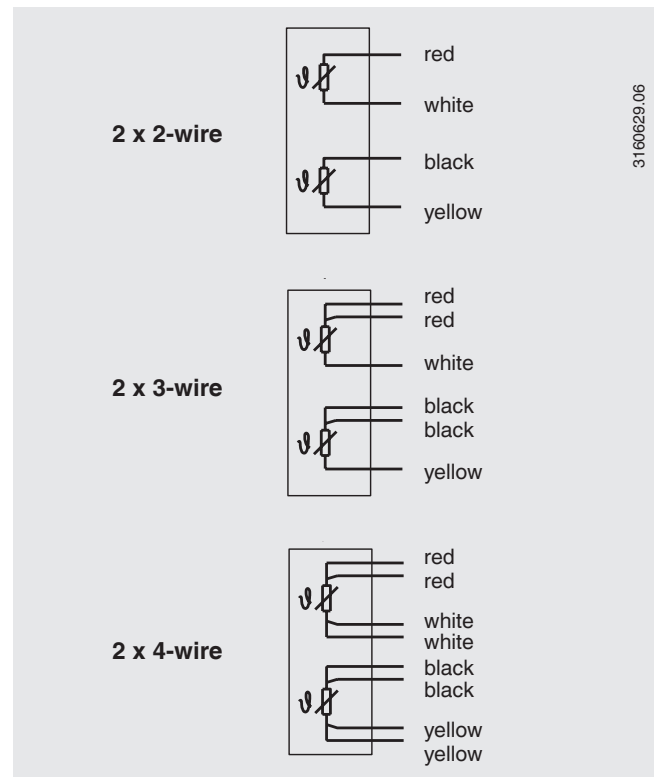

Dimensions in mm

The replaceable measuring insert is made of a vibration-resistant, sheathed measuring cable (MI cable).

Dimensions	
Measuring insert length l_5	≥ 300 mm
Measuring insert diameter $\varnothing d$	<ul style="list-style-type: none"> ■ 3 mm ¹⁾ ■ 6 mm ■ 8 mm (with sleeve) ■ 1/8 in [3.17 mm] ¹⁾ ■ 1/4 in [6.35 mm] ■ 3/8 in [9.53 mm]

1) \varnothing 3 mm not possible with 2 x Pt100, 4-wire

The measuring insert diameter should be approx. 1 mm smaller than the bore diameter of the thermowell. Gaps of more than 0.5 mm between thermowell and the measuring insert will have a negative effect on the heat transfer, and they will result in unfavourable response behaviour of the thermometer.

When fitting the measuring insert into a thermowell, it is very important to determine the correct insertion length (= thermowell length for bottom thicknesses of ≤ 5.5 mm). In order to ensure that the measuring insert is firmly pressed down onto the bottom of the thermowell, the measuring insert must be spring-loaded (spring travel: max 20 mm).

Calculation of the measuring insert length in the event of replacement

Thread to connection head	Measuring insert length l_5
1/2 NPT	NL + 12 mm
M20 x 1.5	NL + 18 mm

NL = Nominal length of the TR12-B or TR12-M

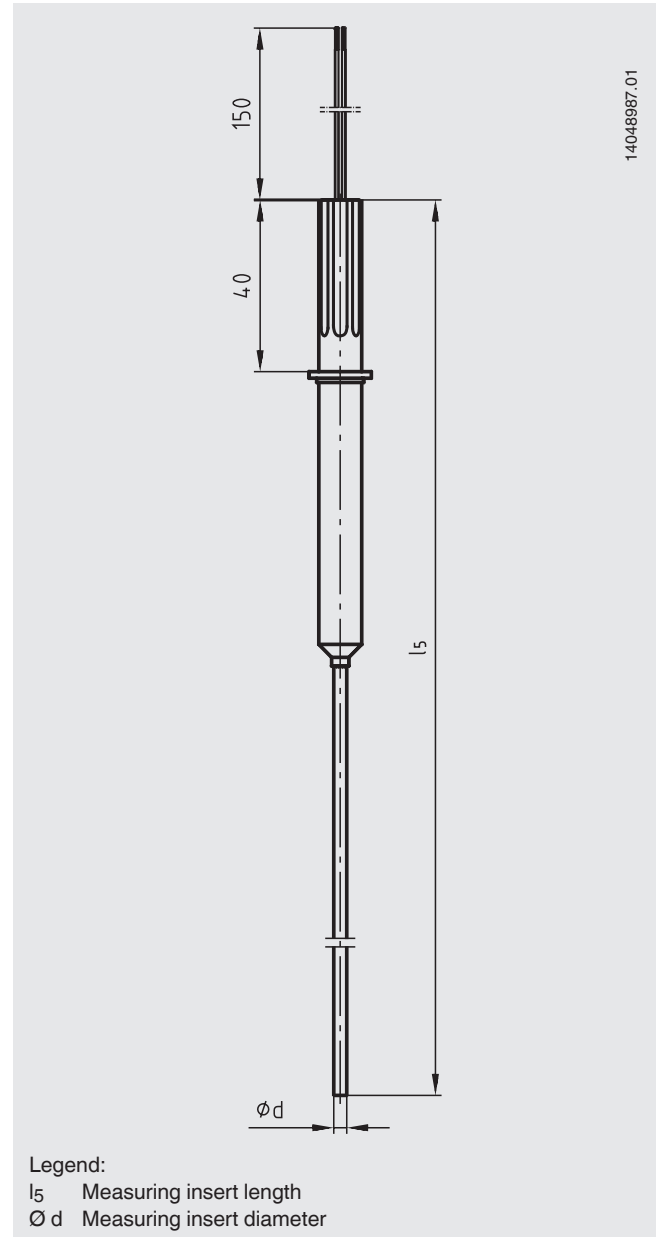
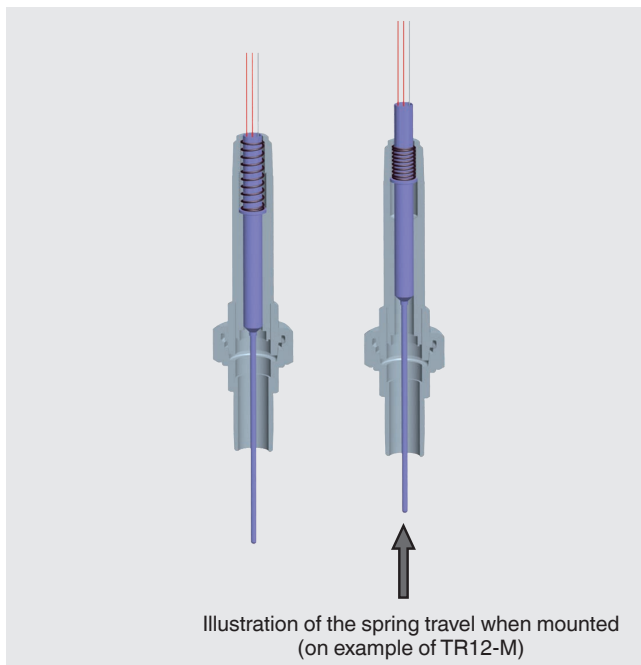

14048987.01

Materials

Materials	
Sheath material	Stainless steel 1.4571
	Stainless steel 316
	Stainless steel 316L

Attention:

The use of a model TR12-A measuring insert is exclusively allowed with a model TR12-B or TR12-M resistance thermometer!

Operating conditions

Mechanical requirements

Version	
Standard	6 g peak-to-peak, wire-wound measuring resistor or thin film
Option	Vibration-resistant sensor tip, max. 20 g peak-to-peak, thin-film measuring resistor
	Highly vibration-resistant sensor tip, max. 50 g peak-to-peak, thin-film measuring resistor

The replaceable measuring insert is made of a vibration-resistant, sheathed measuring cable (MI cable).

Response time (in water, per EN 60751)

$$t_{50} < 10 \text{ s}$$

$$t_{90} < 20 \text{ s}$$

Specifications for measuring insert diameter 6 mm:
The thermowell required for operation increases the response time dependent upon the actual parameters for the thermowell and the process.

Ambient and storage temperature

-60 ¹⁾ / -40 ... +80 °C

1) Special version on request (only available with selected approvals)

Other ambient and storage temperature on request

Ingress protection

IP00 per IEC/EN 60529

The measuring inserts for the model TR12-A are designed for mounting into a model TR12-B resistance thermometer. These resistance thermometers feature connection housings/cable glands/protective fittings which ensure a higher IP protection (see data sheet TE 60.17).

Ordering information

Model / Explosion protection / Ignition protection type / Zone / Sensor / Sensor specification / Application range of the thermometer / Insertion length / Measuring insert diameter Ø d / Sheath material / Mechanical requirements / Certificates / Options

© 09/2012 WIKA Alexander Wiegand SE & Co. KG, all rights reserved.
The specifications given in this document represent the state of engineering at the time of publishing.
We reserve the right to make modifications to the specifications and materials.

Certificates (option)

Certification type	Measuring accuracy	Material certificate
Test report	x	x
2.2 test report	x	x
3.1 inspection certificate	x	x
DKD/DAkkS calibration certificate	x	-

The different certifications can be combined with each other.

The minimum length for carrying out a measurement accuracy test 3.1 or DKD/DAkkS is 100 mm.
Calibration of shorter minimum lengths on request.

